

Released Items

Published January 2019

Grade 7 Mathematics North Carolina End-of-Grade Assessment



Public Schools of North Carolina

Department of Public Instruction | State Board of Education

Division of Accountability Services/North Carolina Testing Program

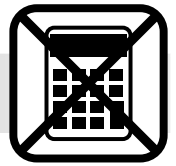

Sample Questions

S1 Kerry walks 3 miles each day. How far will she walk in 7 days?

- A 10 miles
- B 14 miles
- C 21 miles
- D 24 miles

S2 What number is represented by point *P* on the number line below?

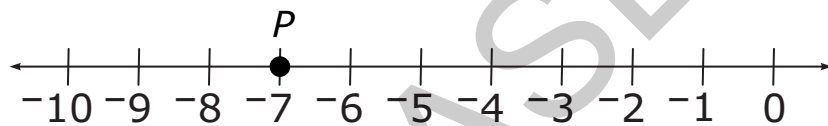

Only 0, 1, 2, 3, 4, 5, 6, 7, 8, 9, ., -, and / are allowed in your answer. Answers that are mixed numbers must be entered as an improper fraction or decimal.

--	--	--	--	--	--



Go to the next page.

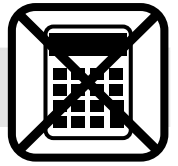

S3 What fraction of the circle is shaded?

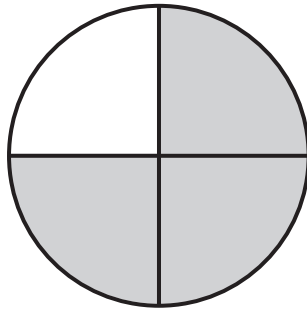

Only 0, 1, 2, 3, 4, 5, 6, 7, 8, 9, ., -, and / are allowed in your answer. Answers that are mixed numbers must be entered as an improper fraction or decimal.

--	--	--	--	--	--

RELEASED



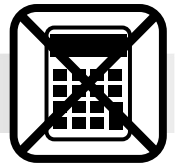

- 1 Which expression has the least value when $x = 100$?
- A $\frac{1}{x}$
- B $\frac{10}{x}$
- C $1 - x$
- D $10 - x$
- 2 The cafeteria staff made sandwiches. Each sandwich had either rye or white bread, either ham or turkey, and either cheese or no cheese. The staff made an equal number of each type of sandwich. The sandwiches were placed on a tray. Without looking, Mary will choose a sandwich. What are the chances that Mary will get a sandwich with cheese?
- A $\frac{1}{8}$
- B $\frac{1}{6}$
- C $\frac{1}{3}$
- D $\frac{1}{2}$
- 3 A 5-lb bag of apples costs \$4.50, and an 8-lb bag of the same type of apples costs \$7.52. Greg found the unit price, which is the constant of proportionality between cost and weight, for each bag of apples. What is the difference in the unit prices?
- A \$0.04 per pound
- B \$0.12 per pound
- C \$0.16 per pound
- D \$0.21 per pound

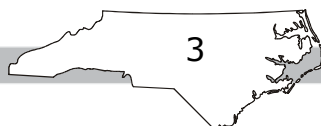

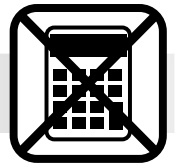

- 4 The scores that Joni and Sally received on their first seven assignments are shown in this table.

Joni	Sally
70	100
60	50
80	90
90	90
90	70
100	70
80	70

Which statement is true?

- A Sally's median score is higher than Joni's median score.
- B Sally's median score is lower than Joni's median score.
- C Sally's median score is the same as Joni's median score.
- D The median scores cannot be determined.
- 5 Which expression is equivalent to $\frac{1}{2}(2n + 6)$?

- A $\frac{1}{2} + 2n + 6$
- B $2\frac{1}{2}n + 6\frac{1}{2}$
- C $n + 6$
- D $n + 3$



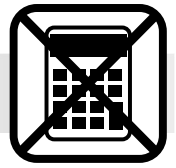

- 6 Susan's weekly earnings were proportional to the number of hours she worked. This table shows the number of hours Susan worked and the amount she earned.

Hours	Earnings (\$)
5	\$47.50
7	\$66.50
9	\$85.50
11	\$104.50

How much money did Susan earn per hour?

- A \$22.50
B \$19.00
C \$9.50
D \$7.50
- 7 Which expression is equivalent to $3x - (2x + 4) + 5$?
- A $x + 9$
B $x + 1$
C $5x + 9$
D $5x + 1$

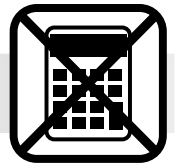

- 8 This table shows the relationship between x and y .

x	y
3	163.5
6	327
11	599.5

Which equation models this relationship?

- A $y = 53x$
- B $y = 53.5x$
- C $y = 54x$
- D $y = 54.5x$
- 9 Which expression is equivalent to $2(3 - x) - 12 + 4x$?
- A $3x - 6$
- B $3x - 7$
- C $2x - 6$
- D $2x - 7$
- 10 Mr. Kelly pays \$12,564 a year for rent. His rent is a constant amount each month. Which equation represents the amount he pays per month if $m =$ months and $c =$ total rent paid for the year?
- A $1,047m = c$
- B $1,047c = m$
- C $1,047 + m = c$
- D $m \div 1,047 = c$

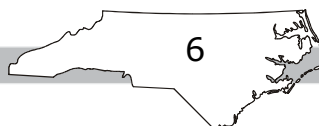

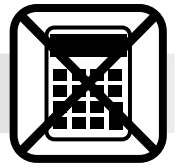

Questions 11 through 15 require you to write your answers in the boxes provided on your answer sheet. A sample grid is shown below each question, but your answer must be properly entered on the answer sheet to be scored. Write only one number or symbol in each box and fill in the circle in each column that matches what you have printed. Fill in only one circle in each column.

11 A library has 12,500 fiction books and 19,000 nonfiction books.

- Currently, $\frac{2}{5}$ of the fiction books are checked out.
- Currently, $\frac{2}{5}$ of the nonfiction books are checked out.
- Of the books checked out, $\frac{1}{10}$ are due back this week.

How many books are due this week?

Only 0, 1, 2, 3, 4, 5, 6, 7, 8, 9, ., -, and / are allowed in your answer. Answers that are mixed numbers must be entered as an improper fraction or decimal.

--	--	--	--	--	--



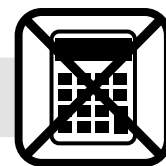

- 12 Kevin is paid \$8.80 per hour. He worked 7 hours. He gave his mother $\frac{1}{4}$ of his earnings. How much did Kevin have left?

(Note: Express the answer as dollars.cents.)

Only 0, 1, 2, 3, 4, 5, 6, 7, 8, 9, ., -, and / are allowed in your answer. Answers that are mixed numbers must be entered as an improper fraction or decimal.

--	--	--	--	--	--

- 13 Square $RSTU$ is inside trapezoid $RSVU$. What is the measure, in degrees, of angle VSR ?

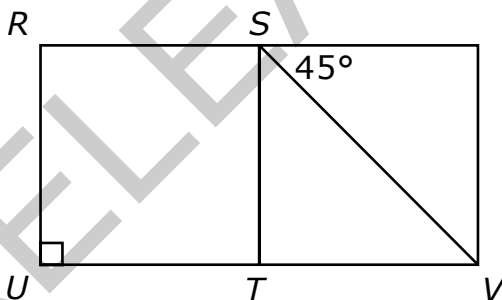

Only 0, 1, 2, 3, 4, 5, 6, 7, 8, 9, ., -, and / are allowed in your answer. Answers that are mixed numbers must be entered as an improper fraction or decimal.

--	--	--	--	--	--

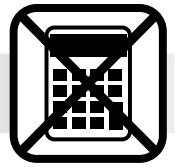

- 14 Janet can make $\frac{4}{5}$ of a necklace in 20 minutes. At this rate, how many necklaces, to the nearest tenth of a necklace, can Janet make in 1 hour?

Only 0, 1, 2, 3, 4, 5, 6, 7, 8, 9, ., -, and / are allowed in your answer. Answers that are mixed numbers must be entered as an improper fraction or decimal.

--	--	--	--	--	--

- 15 Kyle bought x pencils. He paid \$1.24, including tax, per pencil. He gave the cashier \$20 and received \$5.12 in change. How many pencils did Kyle purchase?

Only 0, 1, 2, 3, 4, 5, 6, 7, 8, 9, ., -, and / are allowed in your answer. Answers that are mixed numbers must be entered as an improper fraction or decimal.

--	--	--	--	--	--

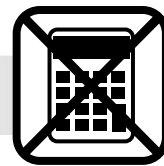

This is the end of the calculator inactive test questions.

Directions:

- 1. Look back over your answers for the calculator inactive questions. You will not be able to go back and work on these questions once you are given a calculator.**
- 2. Raise your hand to let your teacher know you are ready to begin the calculator active test questions.**
- 3. Do not begin work on the calculator active test questions until your teacher has given you a calculator.**

RELEASED

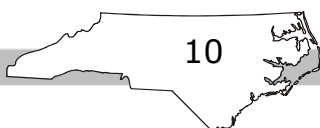

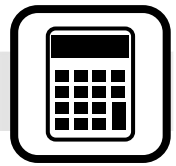

Questions 16 through 20 require you to write your answers in the boxes provided on your answer sheet. A sample grid is shown below each question, but your answer must be properly entered on the answer sheet to be scored. Write only one number or symbol in each box and fill in the circle in each column that matches what you have printed. Fill in only one circle in each column.

16 The angles in this diagram are complementary.

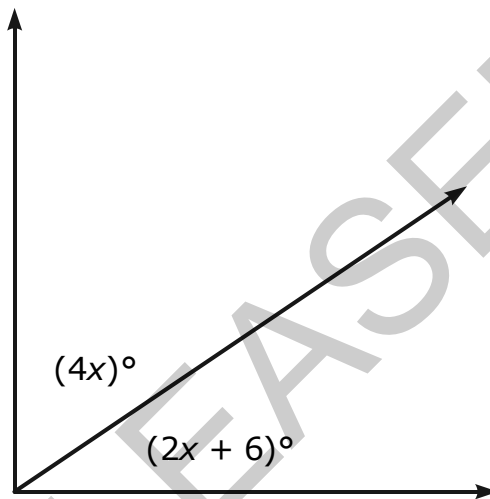

What is the value of x ?

Only 0, 1, 2, 3, 4, 5, 6, 7, 8, 9, ., -, and / are allowed in your answer. Answers that are mixed numbers must be entered as an improper fraction or decimal.

--	--	--	--	--	--

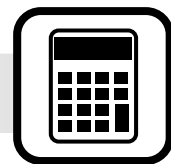

- 17 A car used $\frac{1}{64}$ of a gallon of gas to drive $\frac{1}{4}$ of a mile. At this rate, how many miles can the car travel using 1 gallon of gas?

Only 0, 1, 2, 3, 4, 5, 6, 7, 8, 9, ., -, and / are allowed in your answer. Answers that are mixed numbers must be entered as an improper fraction or decimal.

--	--	--	--	--	--

- 18 Craig earns the same amount of money each month. His telephone bill is $\frac{1}{20}$ of his monthly earnings, and he pays a total of \$720 each year for his telephone service. How much does Craig earn each month, in dollars?

Only 0, 1, 2, 3, 4, 5, 6, 7, 8, 9, ., -, and / are allowed in your answer. Answers that are mixed numbers must be entered as an improper fraction or decimal.

--	--	--	--	--	--

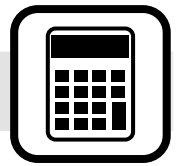

- 19 A recipe requires $\frac{1}{4}$ cup of oil for every $\frac{2}{3}$ cup of water. How much oil (in cups) is needed per cup of water?

Only 0, 1, 2, 3, 4, 5, 6, 7, 8, 9, ., -, and / are allowed in your answer. Answers that are mixed numbers must be entered as an improper fraction or decimal.

--	--	--	--	--	--

- 20 In this figure, ST is a line.

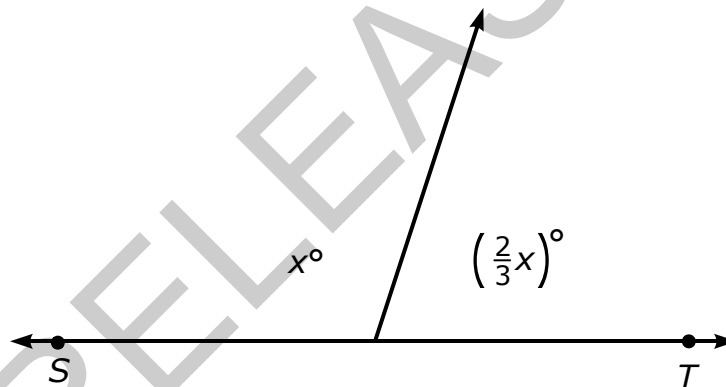

What is the value of x ?

Only 0, 1, 2, 3, 4, 5, 6, 7, 8, 9, ., -, and / are allowed in your answer. Answers that are mixed numbers must be entered as an improper fraction or decimal.

--	--	--	--	--	--

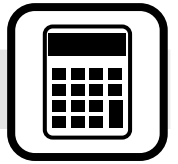

- 21 This table shows how much each type of meat costs at a local deli.

Type of Meat	Price per Pound
ham	\$5.99
turkey	\$4.99
roast beef	\$6.99
salami	\$2.99
bologna	\$3.99

A customer purchased $\frac{1}{4}$ pound of ham, $1\frac{1}{2}$ pounds of turkey, 1 pound of roast beef, and $\frac{3}{4}$ pound of bologna. **Approximately** what will the customer pay for the purchase before sales tax?

- A \$17
- B \$19
- C \$22
- D \$25

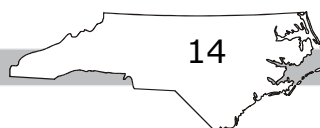

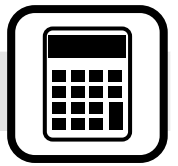

22 Four friends each flipped a coin different numbers of times.

- Alice got heads 75% of the time.
- Mary got heads 8 out of 10 times.
- Sarah got heads 17 out of 20 times.
- Ellen got heads $\frac{3}{5}$ of the time.

Who had the greatest percentage of heads?

- A Alice
- B Mary
- C Sarah
- D Ellen

23 Martin ordered a pizza with a 16-inch diameter. Ricky ordered a pizza with a 20-inch diameter. What is the **approximate** difference in area of the two pizzas?

- A 50 inches²
- B 113 inches²
- C 201 inches²
- D 452 inches²



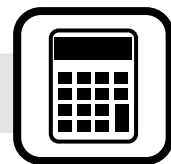

- 24 A state representative took several random surveys of adults to find which place they visited most frequently. The average of all of the surveys is shown in this table.

Place	Average of Surveys
zoo	31
museum	14
park	17
aquarium	8

Based on the table, which conclusion can be made?

- A On average, 50% of the adults visited the zoo most frequently.
- B On average, 17% of the adults visited the park most frequently.
- C On average, 2 out of 25 adults visited the aquarium most frequently.
- D On average, 2 out of 10 adults visited the museum most frequently.
- 25 Tony bought a \$48 sweatshirt and used a coupon for a 10% discount. Keith bought an identical sweatshirt at a different store for \$42.95. Which statement is true?
- A Tony paid \$0.25 less than Keith paid.
- B Tony paid \$4.95 less than Keith paid.
- C Keith paid \$0.25 less than Tony paid.
- D Keith paid \$4.95 less than Tony paid.

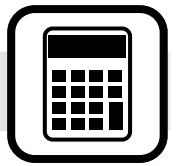

- 26 Which expression is equivalent to $-\frac{1}{2}\left(\frac{1}{4}x - \frac{3}{8}\right)$?
- A $-\frac{1}{8}x + \frac{3}{16}$
- B $-\frac{1}{8}x + \frac{3}{8}$
- C $\frac{1}{8}x - \frac{3}{16}$
- D $\frac{1}{8}x - \frac{3}{8}$
- 27 Erica saw a skateboard on sale for \$59.95. The original price of the skateboard was \$79.95. What is the **approximate** percent discount on the skateboard?
- A 20%
- B 25%
- C 75%
- D 80%
- 28 Jane wants to pick out an outfit for the school dance. She can choose from 3 pairs of pants, 5 shirts, and 2 pairs of shoes. How many different outfits does Jane have to choose from?
- A 10
- B 15
- C 30
- D 60

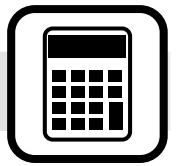

29 This diagram is a scale drawing of a store.

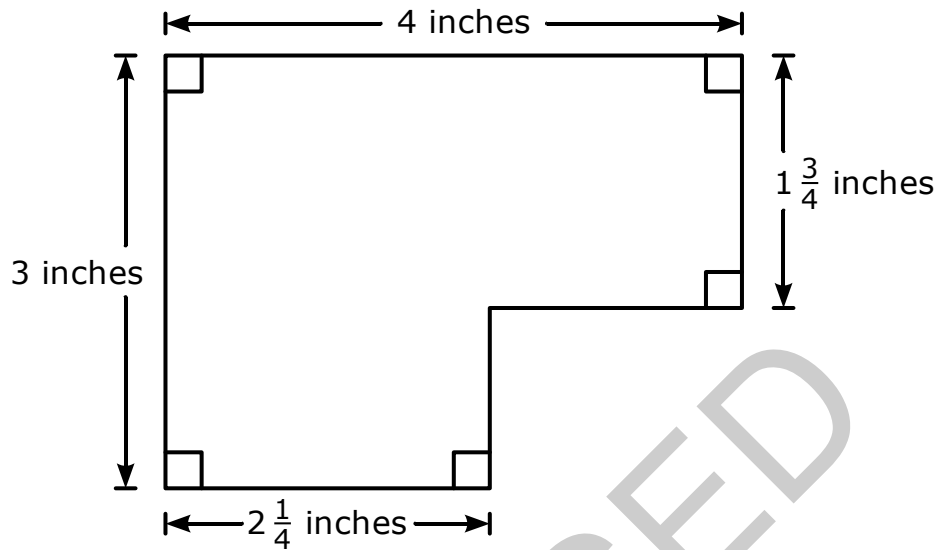

Scale: 1 inch = 16 feet

To the nearest 50 square feet, what is the area of the actual store?

- A 2,350 square feet
- B 2,400 square feet
- C 2,450 square feet
- D 2,500 square feet

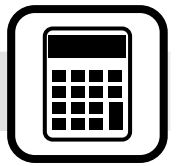

30 This spinner will be spun twice.

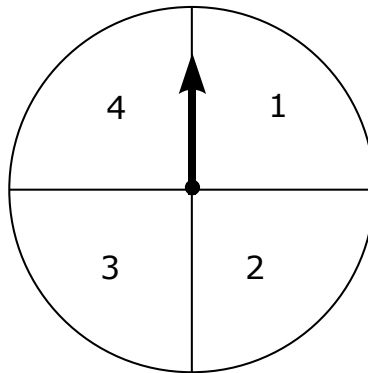

What is the probability of spinning an odd number both times?

- A $\frac{1}{8}$
- B $\frac{1}{4}$
- C $\frac{1}{2}$
- D $\frac{3}{4}$

31 Which choice describes the value of m when $-5(m + 1) \leq 23$?

- A $m \geq \frac{-28}{5}$
- B $m \leq \frac{-28}{5}$
- C $m \geq \frac{-18}{5}$
- D $m \leq \frac{-18}{5}$

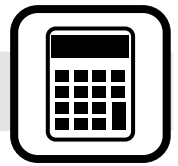

- 32 Paul has a spinner with 4 colors: green, yellow, blue, and orange. He spins the spinner 60 times and records each color it stops on. The results are shown in this table.

Color	green	yellow	blue	orange
Frequency	12	19	14	15

Paul will spin the spinner an additional 450 times. How many times should he expect the spinner to stop on blue?

- A 140
 - B 124
 - C 113
 - D 105
- 33 Circle M has a radius of 7.0 cm. The shortest distance between P and Q on the circle is 7.3 cm.

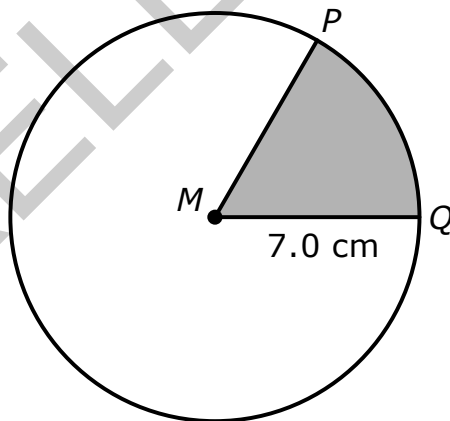

What is the **approximate** area of the shaded portion of circle M ?

- A 153.9 cm^2
- B 44.0 cm^2
- C 25.6 cm^2
- D 21.0 cm^2

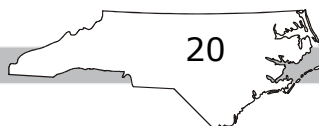

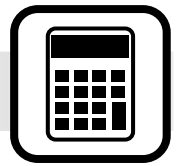

- 34 Nicole wants to conduct a survey of the opinions of students at her middle school. Which survey sample would give her the most accurate results?
- A random students as they enter the school
 - B students during math class
 - C random seventh-grade students during lunch
 - D teachers in the seventh-grade hallway
- 35 A teacher divided the class into two groups of equal size.
- $\frac{3}{5}$ of the first group are right-handed.
 - 80% of the second group are right-handed.

What fraction of the class is right-handed?

- A $\frac{8}{9}$
- B $\frac{4}{5}$
- C $\frac{7}{10}$
- D $\frac{5}{7}$

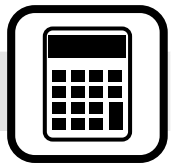

36 This graph shows time and distance traveled for two objects.

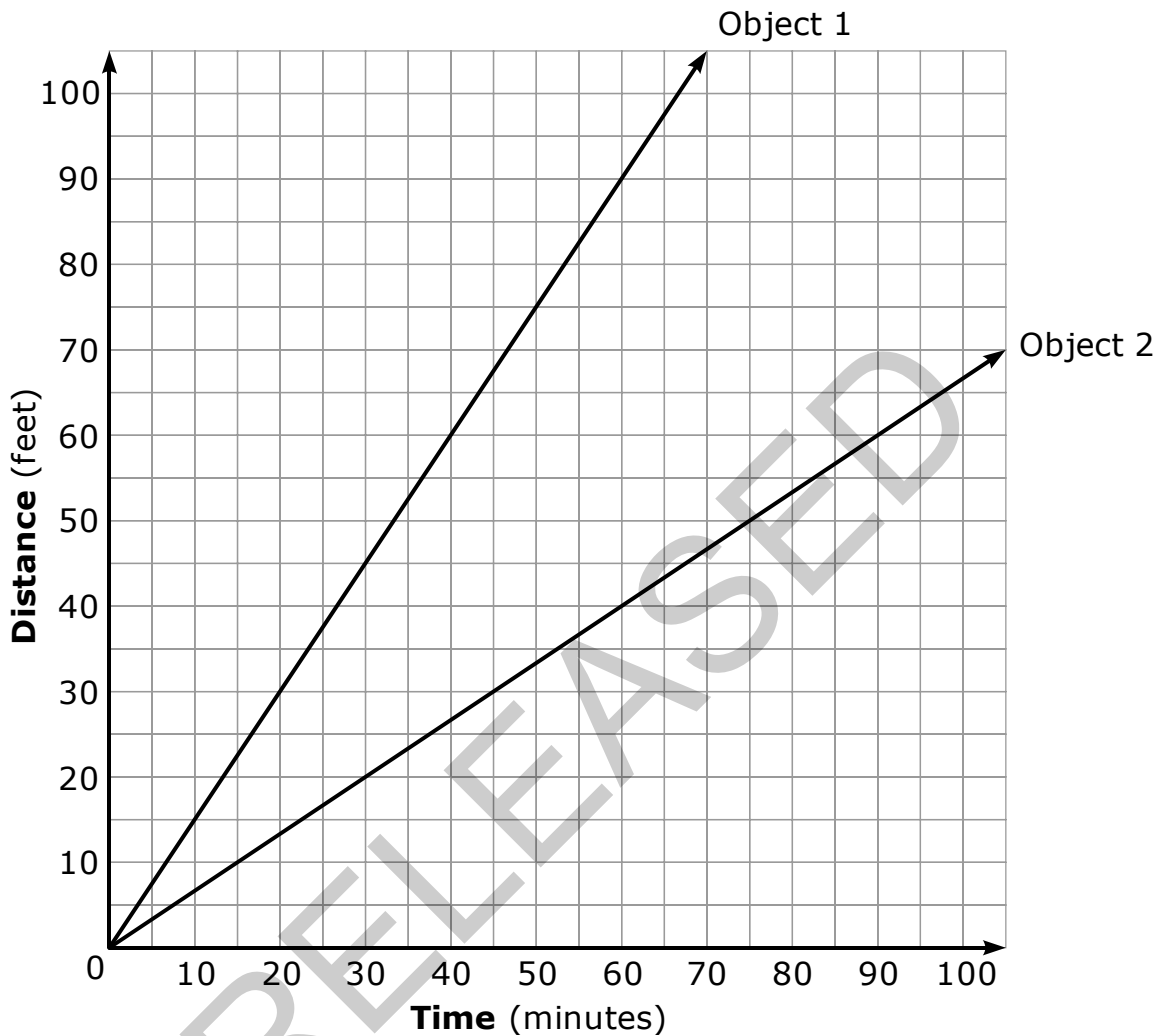

Which statement is true?

- A Object 2 travels $\frac{6}{5}$ of a foot more per minute than Object 1.
- B Object 2 travels $\frac{5}{6}$ of a foot more per minute than Object 1.
- C Object 1 travels $\frac{6}{5}$ of a foot more per minute than Object 2.
- D Object 1 travels $\frac{5}{6}$ of a foot more per minute than Object 2.

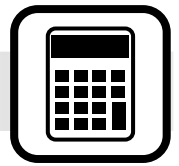

37 Jamal, Gary, Charlie, and Brian are going to stand in a line, one behind the other. In how many different ways can they stand in the line?

- A 24
- B 16
- C 10
- D 4

38 What is the value of y when $-5 = \frac{y-7}{9}$?

- A -7
- B -11
- C -38
- D -52

39 Which choice has a value that is closest to the value of the following expression?

$$\frac{17}{12} - \frac{49}{40}$$

- A $\frac{1}{4}$
- B $\frac{1}{5}$
- C $\frac{1}{6}$
- D $\frac{1}{7}$

RELEASED

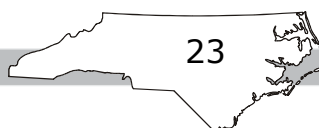

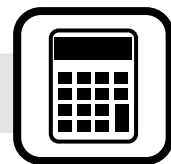

- 40 The equation $y = 6.75x$ models the cost, in dollars, to purchase x pounds of steak at grocery store 1. This table shows the cost to buy different weights of steak at grocery store 2.

Cost of Steak at Grocery Store 2

Weight (pounds)	Cost
2	\$15.00
3	\$22.50
5	\$37.50
9	\$67.50

Which statement is true?

- A The cost of steak at grocery store 1 is \$0.75 less per pound than at grocery store 2.
- B The cost of steak at grocery store 1 is \$0.75 more per pound than at grocery store 2.
- C The cost of steak at grocery store 1 is \$0.50 less per pound than at grocery store 2.
- D The cost of steak at grocery store 1 is \$0.50 more per pound than at grocery store 2.

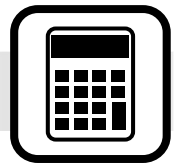

41 This table shows the number of points two teams scored in five games.

Team 1	Team 2
51	27
47	55
35	53
48	38
64	41

What is the difference in the mean absolute deviation of the two teams?

- A 2.16
- B 6.2
- C 7.0
- D 8.96

42 Daniel earned \$8.00 per hour at his job.

- Daniel works 35 hours each week.
- He received a 5% pay increase.

How much more money will Daniel earn each week after the pay increase?

- A \$5
- B \$14
- C \$39
- D \$48

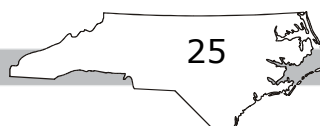

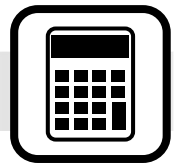

43 The test scores for the students in Mr. Miller’s math class are shown here.

52, 61, 69, 76, 82, 84, 85, 90, 94

What is the range of the test scores?

- A 82.0
- B 77.0
- C 42.0
- D 22.5

44 The two ends of this triangular right prism are equilateral triangles. The measurements are given to the nearest tenth of a cm.

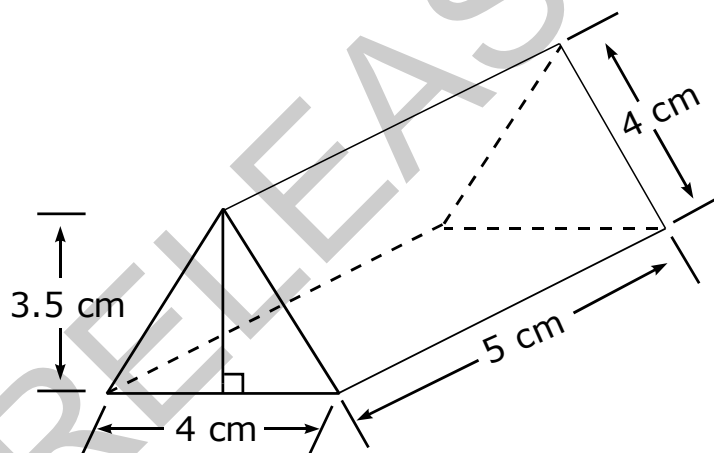

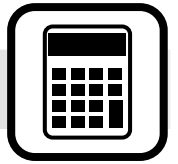

What is the surface area of the prism?

- A 70 cm^2
- B 74 cm^2
- C 140 cm^2
- D 280 cm^2

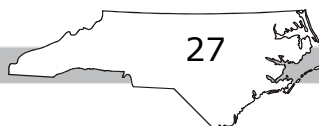

- 45 The probability that a person in a certain town has brown eyes is 2 out of 5. A survey of 450 people from that same town was taken. How many people would be expected to have brown eyes?
- A 45
 - B 90
 - C 180
 - D 225

RELEASED

Go to the next page. 

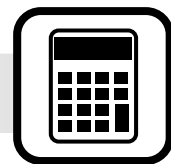

Directions:

This is the end of the mathematics test.

- 1. Put all of your papers inside your test book and close your test book.**
- 2. Place your calculator on top of the test book.**
- 3. Stay quietly in your seat until your teacher tells you that testing is finished.**

RELEASED

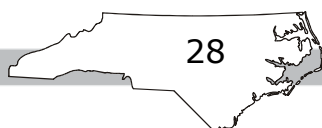

**Grade 7 Mathematics
RELEASED Form
2018–2019
Answer Key**

Item Number	Type	Key	Domain
S1	MC	C	
S2	GR	-7	
S3	GR	3/4	

Calculator Inactive



Item Number	Type	Key	Domain
1	MC	C	NC.7.NS.3
2	MC	D	NC.7.SP.7.a
3	MC	A	NC.7.RP.2.b
4	MC	B	NC.7.SP.4
5	MC	D	NC.7.EE.1
6	MC	C	NC.7.RP.2.b
7	MC	B	NC.7.EE.1
8	MC	D	NC.7.RP.2.c
9	MC	C	NC.7.EE.1
10	MC	A	NC.7.RP.2.c
11	GR	1260	NC.7.NS.3
12	GR	46.20	NC.7.NS.3
13	GR	135	NC.7.G.5
14	GR	2.4	NC.7.RP.1
15	GR	12	NC.7.EE.4.a

Calculator Active



Item Number	Type	Key	Domain
16	GR	14	NC.7.G.5
17	GR	16	NC.7.RP.1
18	GR	1200	NC.7.NS.3
19	GR	$\frac{3}{8}$	NC.7.RP.1
20	GR	108	NC.7.G.5
21	MC	B	NC.7.RP.3
22	MC	C	NC.7.EE.3
23	MC	B	NC.7.G.4
24	MC	D	NC.7.SP.2
25	MC	C	NC.7.RP.3
26	MC	A	NC.7.EE.1
27	MC	B	NC.7.RP.3
28	MC	C	NC.7.SP.8.b
29	MC	D	NC.7.G.1
30	MC	B	NC.7.SP.8.a
31	MC	A	NC.7.EE.4.b
32	MC	D	NC.7.SP.6
33	MC	C	NC.7.G.4
34	MC	A	NC.7.SP.1
35	MC	C	NC.7.EE.3
36	MC	D	NC.7.RP.2.a
37	MC	A	NC.7.SP.8.b
38	MC	C	NC.7.EE.4.a
39	MC	B	NC.7.NS.3
40	MC	A	NC.7.RP.2.a

GRADE 7 MATHEMATICS — RELEASED FORM

Item Number	Type	Key	Domain
41	MC	A	NC.7.SP.4
42	MC	B	NC.7.EE.3
43	MC	C	NC.7.SP.3.a
44	MC	B	NC.7.G.6
45	MC	C	NC.7.SP.7.a

RELEASED